

# English Manual

---

---

**2817B/2811C**  
**LCR METER**

---

# Chapter 1      Preparation

1.1 Check the package according to the packing list.

1.2 Power supply requirement:

- (1) Voltage range: 198V-242V or 99V-121V.
- (2) Frequency range: 47.5Hz-63Hz.
- (3) Power range:  $\leq 20VA$ .
- (4) Live wire, null wire and earth wire should fit with the power adapter of this meter.
- (5) This meter has been designed carefully to decrease the clutter interference from AC power, but it still should be used under the low-noise environment; If high-noise is unavoidable, please install power filter.

-----  
-----  
**Warning:** in order to prevent the harm to users or meter due to the power leakage, users have to ensure the earth wire connects with the earth reliably.  
-----  
-----

1.3 Environment:

- (1) Please don't use this meter under the dusty, vibrated, direct-sunlight and corrosive-gas conditions.
- (2) Working temperature:  $0^{\circ}C - 40^{\circ}C$ ; Relative humidity:  $\leq 75\%$ .
- (3) This meter has been designed carefully to decrease the clutter interference from AC power, but it still should be used under the low-noise environment; If high-noise is unavoidable, please install power filter.
- (4) If unused for long time, please put this meter into the origin or similar package. The storage temperature:  $5^{\circ}C - 40^{\circ}C$ ; Relative humidity:  $\leq 85\%$ . No corrosive materials in the air and direct sunlight.
- (5) The meter, especially the testing leads connected with the samples, should stay away from the strong electromagnetic field to avoid the interference for the measurement.

1.4 Use measuring fixture:

Please use the measuring fixtures or test leads which come from the manufacturer. Any other measuring fixtures or test leads from other sources may cause the incorrect measurement. Measuring fixtures, test leads and pins of samples should keep clean to ensure the good contact. Connect measuring fixtures or test leads with **Hcur**, **Hpot**, **Lcur** and **Lpot** terminals on the front panel of the meter. For the shielded enclosure, users can connect the shielding layer with "⊥" of the meter.

1.5 Warm-up and continuous working hours:

To ensure correct measurement, warm-up time should be not less than 15 minutes; continuous working hours should be not more than 16 hours.

## 1.6 Other characteristics:

- (1) Power consumption:  $\leq 20\text{VA}$
- (2) Dimension(WxHxD): 350mm x 110mm x 340mm
- (3) Weight: 7.2kg.

# Chapter 2 Panel Introduction



### (1) First-level Menu

FUN:	Cs-D		
F:	1.0kHz	<b>Cs:</b>	<b>1.0000uF</b>
LEVE:	1.0V		
RANGE:	AUTO		
SPEED:	MED		
CLEAR:	OFF	<b>D:</b>	<b>0.0001</b>
IN_R:	30R		
MODE:	TOL		

Figure 4.1

**First-level menu is shown as Figure 4.1; Display definition is as follows:**

Display	Definition
FUN	Measuring parameters. Can choose: Cs-D, Cp-D, Ls-Q, Lp-Q, Z-D, R-Q, total 6 parameter groups are available.
F	<u><b>.2811C/2811D measuring frequency.</b></u> Can choose: 100Hz, 120Hz, 1kHz, 10kHz, total 4 frequencies are available. <u><b>2817B measuring frequency.</b></u> Can choose: 50Hz, 60Hz, 80Hz, 100Hz, 120Hz, 200Hz, 400Hz, 500Hz, 800Hz, 1kHz, 2kHz, 4kHz, 5kHz, 8kHz, 10kHz, 20kHz, 25kHz, 40kHz, 50kHz, 100kHz, total 20 frequencies are available.
LEVE	Testing level. Can choose: 1V, 0.3V, 0.1V
RANGE	Testing range. Can choose AUTO and HOLD
SPEED	Testing speed. Can choose: FAST, MED, SLOW
CLEAR	Clear data
IN_R	Internal resistance. Can choose: 30Ω and 100Ω
MODE	Display mode. Can choose: TOL and TOL%

## (2) Second-level menu

NOMINAL:		[BIN]	[LOW]	[HIGH]
1.0000uF		1	-00.00%	00.00%
COMP:	ON	2	-00.00%	00.00%
ALARM:	ON	3	-00.00%	00.00%
TRIG:	INT	D	0.0000	0.0000
RS232:	ON			

# Chapter 3      Operation

2811D/2817B/2816C LCR meters base on MCU technologies. It can measure inductance L, capacitance C, resistance R, dissipation factor D, quality factor Q, and impedance Z. The meter combines the useful function, good performance and simple operation as a whole. It can be used to measure component parameters in factories or colleges. In order to ensure the accuracy, users can clear stray capacitance from testing clips and wire resistance via "Clear" function.

## 1. General operation

**3.1** Connect with power supply, press power switch to "on", there should be variable numbers on the screen, otherwise please restart the meter.

**3.2** Warm-up more than 15 minutes before measurement.

**3.3** Select correct measuring fixtures or cables; Keep the samples clean and ensure they have good contact with testing terminals.

**3.4** Select corresponding measurement conditions according to requirements of samples.

## 2. First-level menu operation:

**3.2.1 Parameter settings:** Press "PARAMETER" key, change measuring parameters. When users press this key, parameter is anti-color display; loose this key, anti-color bar disappear.

**3.2.2 Frequency settings:** Press "FREQUENCY" key, change measuring frequency. Holding this key can change the frequency continually.

**3.2.3 Level settings:** Press "LEVEL" key, change measuring level. Holding this key can change the level continually.

**3.2.4 Speed settings:** Press "SPEED" key, change measuring speed. There are 3 choices: "Fast", "Middle" and "Slow", namely, 10 times/sec, 6 times/sec and 2 times/sec.

**3.2.5 Range settings:** Press "RANGE" key, change "range" status. Parameters anti-color display. "HOLD" means "Range Lock"; "AUTO" means "Range unlock".

**3.2.6 Clear settings:** Press "CLEAR" key, change "clear" status. Parameters anti-color display. "ON" means "clear function on"; "OFF" means "clear function off".

(When users need to change parameters and frequency, please close clear function.)

**3.2.7 Impedance settings:** Press "IMPEDANCE" key, change measuring internal impedance.

**3.2.8 Show settings:** Press "SHOW" key, change "show" status. Behind "MODE", parameters anti-color display. "TOL%" means "display %"; "TOL" means direct display.









### (1) Second-level menu

NOMNAL:		[BIN]	[LOW]	[HIGH]
1.0000uF		1	-00.00%	00.00%
COMP:	ON	2	-00.00%	00.00%
ALARM:	ON	3	-00.00%	00.00%
TRIG:	INT	D	0.0000	0.0000
RS232:	ON			

Second-level menu is used for setting the limits of stalls when components are sorting. Users have to set the limits for component sorting. There are 2 limits for every stall: upper limit and inferior limit.









Display	Definition
NOMNAL	Nominal value settings
COMP	Component sorting switch settings
ALARM	Alarm switch settings
TRIG	Trigger mode settings( <b>optional</b> )
RS232	RS232 settings( <b>optional</b> )
1	Stall 1 settings
2	Stall 2 settings
3	Stall 3 settings
D/Q	Secondary parameter

### 3.3 Secondary parameter settings:

Press "SET" key twice to enter second-level menu. Press ,  and   to move anti-color bar and make "D" anti-color display, press "ENTER" key, then the first digit behind "D" will be anti-color display, press ,  to move anti-color bar, press   to set the values in the anti-color position.

Press "EXIT" key after finishing secondary parameter settings. The meter will store the current settings automatically.









### 3.4 Limited values of stall settings:

Press "SET" key twice to enter second-level menu. Press ,  and   to move anti-color bar and make "1" anti-color display, press "ENTER" key, then the first digit behind "1" will be anti-color display, press ,  to move anti-color bar, press   to set the values in the anti-color position.

Press "EXIT" key after finishing settings. The meter will store the current settings automatically.







Stall "2" and "3" settings are the same with operation above.

### 3.5 Nominal value settings:

Press "SET" key twice to enter second-level menu. Press ,  and   to move anti-color bar and make "NOMINAL" anti-color display, press "ENTER" key, then the first digit under "NOMINAL" will be anti-color display, press ,  to move anti-color bar, press   to set the values in the anti-color position.

Press "EXIT" key after finishing settings. The meter will store the current settings automatically.







### 3.6 Component sorting settings:

Press "SET" key twice to enter second-level menu. Press ,  and   to move anti-color bar and make "COMP" anti-color display, press "ENTER" key, then the bar behind "COMP" will be anti-color display, press   to set the values in the

anti-color position. "ON" means "component sorting function on"; "OFF" means "component sorting function off".

Press "EXIT" key after finishing settings. The meter will store the current settings automatically.

### 3.7: Alarm settings:

Press "SET" key twice to enter second-level menu. Press ,  and   to move anti-color bar and make "ALARM" anti-color display, press "ENTER" key, then the bar behind "ALARM" will be anti-color display, press   to set the values in the anti-color position. "ON" means "Alarm function on"; "OFF" means "Alarm function off".

Press "EXIT" key after finishing settings. The meter will store the current settings automatically.

## Chapter 4

# Basic features and specifications

### 4.1 Measuring parameters:

Inductance L, Capacitance C, Resistance R, Quality factor Q, dissipation factor D, Impedance Z.

### 4.2 Measuring frequency: ±2% (2811D, 100Hz-10KHz; 2817B, 50Hz-100KHz; 2816C, 50Hz-200KHz)

50Hz, 60Hz, 80Hz, 100Hz, 120Hz, 200Hz, 400Hz, 500Hz, 800Hz, 1kHz, 2kHz, 4kHz, 5kHz, 8kHz, 10kHz, 20kHz, 25kHz, 40kHz, 50kHz, 100kHz, 200kHz

### 4.3 Measuring parameter groups:

L-Q    C-D    R-Q    Z-Q

### 4.4 Equivalent Circuit: Series and Parallel





Actual inductors, capacitors and resistors are not ideally pure reactance or resistance components, but the complex impedance components presented by series or parallel way. This meter calculates the required values on the base of equivalent series or parallel circuit. Different equivalent circuits will cause different results. Both equivalent circuits can switch each other by the formulas as listed in figure 4.1. For Q and D, no matter what the equivalent way is, the result is the same.

**Figure 4.1** Equivalent circuit

Circuit Dissipation D Equivalent way

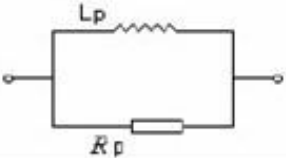
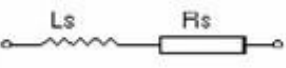
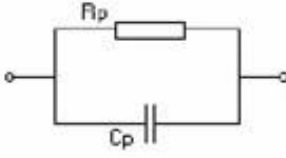
Figure 4-1 Equivalent circuit conversion

	Circuit form	Loss D <sup>+</sup>	Equivalent mode conversion
L <sup>+</sup>		$D=2\pi FLp Rp=1/Q^+$	$Ls=Lp/(1+D)^+$ $Rs=RpD/(1+D)^+$
		$D=Rs/2\pi FLs=1/Q^+$	$Lp=(1+D)Ls^+$ $Rp=(1+D)Rs/D^+$
C <sup>+</sup>		$D=1/2\pi FCpRp=1/Q^+$	$Cs=(1+D)Cp^+$ $Rs=RpD/(1+D)^+$
		$D=2\pi FCsRs=1/Q^+$	$Cp=Cs(1+D)^+$ $Rp=Rs(1+D)/D^+$

**Q, D, Xs definition; Q=Xs/Rs, D=Rs/Xs, Xs=1/2πFCs=2πFLs**

**Note:** for component parameters, subscript s means equivalent series, p means equivalent parallel.

Generally, for low-value impedance components (high-value capacitors and low-value inductors), we should use equivalent series circuit; In contrast, for high-value impedance components (low-value capacitors and high-value inductors), we should use equivalent parallel circuit. But Meanwhile, we must choose the equivalent circuit according to actual situation, for example, the capacitor, when it's used for power filter, should use equivalent series circuit; when it's used for LC oscillation circuit, should use equivalent parallel circuit.

#### 4.5 Range

2811D/2817B/2816C uses 5 ranges totally: 10Ω, 100Ω, 1kΩ, 10kΩ and 100kΩ.

Range can choose auto or hold status. Measuring range will base on the impedance of sample and each effective measuring span, no matter the sample is capacitor or

inductor.

## 4.6: Measuring terminals

4 measuring terminals:  
Hcur: High current excitation;  
Hpot: High voltage sampling;  
Lpot: Low voltage sampling;  
Lcur: Low current excitation.

## 4.7: Measuring speed

Measuring frequency, integral time, component values, display mode, range mode and comparator all will affect measuring speed. 2811D/2817B/2816C provide Fast, MED and SLOW, total 3 measuring speeds for the users. In general, if the measuring speed is slower, the readings will be more stable and accurate.

FAST: 10 times/second; MED: 5.1 times/second; SLOW: 2.5 times/second.

## 4.8: Selection of Signal source resistance

2811D/2817B/2816C can provide  $30\Omega$  and  $100\Omega$ , two signal source resistances are selectable. At the same measuring voltage, choose different signal source resistance, and we will get the different measuring current. If the sample is sensitive to the measuring current, that will cause different results. It's convenient to compare with other manufacturers' measuring results via these two signal source resistance.

## About measuring level

Exactly, the measurement for inductors should use small measuring current whenever possible (namely, small measuring level). Different meters will get different measuring results because their measuring signal currents are different. It depends on the signal source resistance of output voltage from meters.

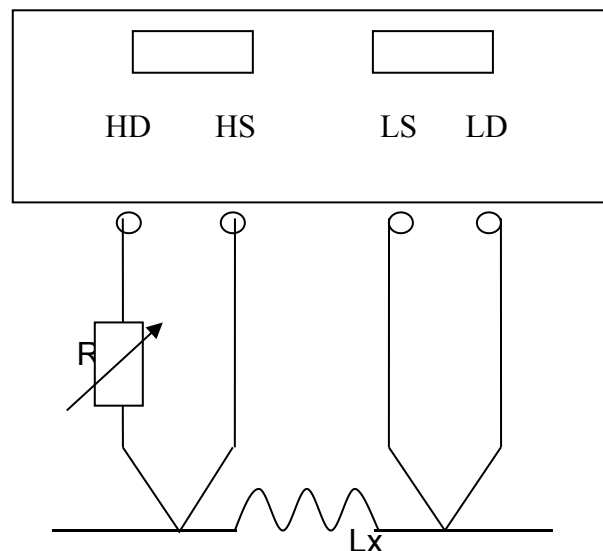

**Figure 7-3** Sketch for signal source resistance

adjustment

If we impose a high measuring signal on the inductor, on some specific frequencies,

maybe we can't measure accurately. That is due to the nonlinear of iron core. And it will cause distortion for the measuring signal current. In order to reduce distortion, we should decrease the measuring signal level.

## 4. 9: Selection of series or parallel

### Selection of equivalent circuit for capacitor

Small capacitance correspond to high impedance, and parallel resistance affect more than series resistance. Compare series resistance with impedance of capacitor, series resistance is much smaller and negligible. So, we should select equivalent parallel to measure.

In contrast, big capacitance correspond to low impedance, and series resistance affect more than parallel resistance. Compare to impedance of capacitor, parallel resistance is much bigger and negligible. So, we should select equivalent series to measure.

Generally, we can select the equivalent circuit for capacitor according to the rules below.

> 10k $\Omega$ , select parallel;

< 10 $\Omega$ , select series.

Between 10 $\Omega$  and 10k $\Omega$ , please select the suitable equivalent circuit according to component manufacturer's recommendation.

### Selection of equivalent circuit for inductor

Big inductance correspond to high impedance, and parallel resistance affect more than series resistance. So, equivalent parallel is more suitable for the measurement.

In contrast, small inductance correspond to low impedance, series resistance affect more than parallel resistance. So, equivalent series is more suitable for the measurement. Generally, we can select the equivalent circuit for inductor according to the rules below.

> 10k $\Omega$ , select parallel;

< 10 $\Omega$ , select series;

Between 10 $\Omega$  and 10k $\Omega$ , please select the suitable equivalent circuit according to component manufacturer's recommendation.

## 4.10: Basic accuracy

C:  $0.1\% (1 + C_x/C_{max} + C_{min}/C_x)(1 + D_x)(1 + k_s + k_v + k_f)$ ;

L:  $0.1\% (1 + L_x/L_{max} + L_{min}/L_x)(1 + 1/Q_x)(1 + k_s + k_v + k_f)$ ;

Z:  $0.1\% (1 + Z_x/Z_{max} + Z_{min}/Z_x)(1 + k_s + k_v + k_f)$ ;

R:  $0.1\%(1 + R_x/R_{max} + R_{min}/R_x)(1 + Q_x)(1 + k_s + k_v + k_f)$ ;

D:  $\pm 0.0020(1 + Z_x/Z_{max} + Z_{min}/Z_x)(1 + D_x + D_x^2)(1 + k_s + k_v + k_f)$ ;

Q:  $\pm 0.0020(1 + Z_x/Z_{max} + Z_{min}/Z_x)(Q_x + 1/Q_x)(1 + k_s + k_v + k_f)$ ;

**Note:** 1. D and Q are absolute error, others are relative error,  $D_x = 1/Q_x$ ;

2. Subscript x means the measuring value, max means maximum values, min means minimum value;
3. ks means speed factor, kv means voltage factor, kf means frequency factor;
4. In order to ensure accuracy of measurement, users should calibrate accuracy under the current measuring conditions and tools with reliable open circuit and short circuit and clear "zero".

#### 4.11: Model number

Model number	Frequency(Hz)	Parameter	Accuracy
2817B	50/60/80//100/120/200/400/500/800/1k/2k/4k/5k/8k/10k/20k/25k/40k/50k/100k	L C R D Q	0.1%
2811D	100Hz, 120Hz, 1kHz, 10kHz	L C R	0.1%
2816C	50/60/80//100/120/200/400/500/800/1k/2k/4k/5k/8k/10k/20k/25k/40k/50k/100k/200k	L C R D Q	0.1%

#### 4.12: Range

Parameter	Frequency	Measuring range
L	50Hz - 800Hz	1uH - 9999H
	1kHz	0.1uH - 999.9H
	10kHz - 200kHz	0.01uH - 99.99H
C	50Hz - 800Hz	1pF - 19999uF
	1kHz	0.1pF - 1999.9uF
	10kHz - 200kHz	0.01pF - 19.99uF
R		0.001Ω - 39.999MΩ
D		0.0000 - 9999
Q		0.0000 - 9999
Parameter	Display range	
L	0.0001μH - 99999H	
C	0.0001pF - 99999mF	
R/Z	0.0001mΩ - 99999MΩ	
Q	0.0001 - 99999	
D	0.0001 - 99999	

## Chapter 5 About accuracy

5. 1 For the whole measuring range, the accuracy complies with the curve below.

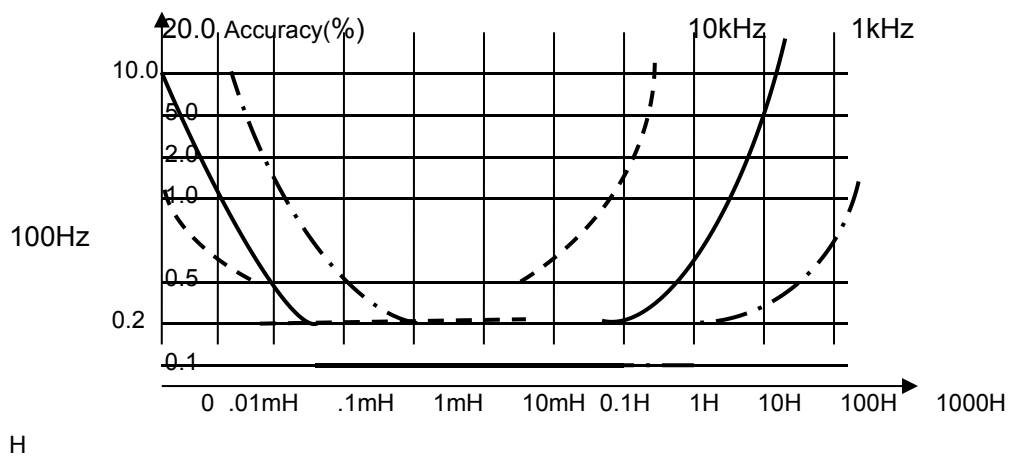

5.2. Accuracy for Quality Factor in the whole range:  $\pm[0.030+0.2(1+Q)\%]$

5.3. Accuracy for Dissipation in the whole range:  $\pm[0.0030+0.5D(1+D)\%]$

## Chapter 6 Maintenance and Notice

6. 1. The meter should connect with earth reliably.

6.2. If this meter displays the chaotic or disordered data, users can recover it to factory

setting by the following steps. Power off the meter, and then hold any key, power on the meter.

6.3. Warm-up ten minutes, and let the meter work stably. Don't use this meter in the harsh environment. Keep this meter clean. All these are for avoiding the bad effect to the performance and accuracy.

6.4. Please try to use Range Lock function whenever possible to improve measuring speed for massive samples.

6.5. When the meter can't power on normally or the interference makes the meter function wrong, please restart the meter.

6.6. Please keep the testing cables in the same position after short circuit and clear-zero, otherwise the electromagnetic coupling between the testing cables will cause unstable measuring readings or inaccuracy clear-zero data.

6.7. Please contact with us when the meter malfunctions.

## **Chapter 7**

### **Correct measurement for inductor**

#### **7.1.Characteristics of Inductor**

The inductor is made of a wire surrounding the magnetic core. Its characteristics depend on the materials for magnetic core. Air, we can say it's the simplest material for magnetic core, but because the inductance is proportional to magnetic permeability of magnetic core, and magnetic permeability of air is very small, considering the volume efficiency, so air is not used to make inductors. Usually, people use magnetic materials, like ferrite, high-permeability magnetic alloy or pure ferrite. Most inductance will change dramatically when we use different frequencies and levels to measure. The inductance for the inductor will be affected by the magnetic permeability  $\mu$ . Magnetic induction intensity of the core changes as the magnetic field intensity changes. (The magnetic field is generated by the current following through the coils) Their relation can be described by a magnetization curve. Figure 7-1 shows a typical magnetization curve for inductor coil.

When magnetic material imposes a static magnetic field, its magnetic induction intensity will increase with current increase. Inductance  $L$ , magnetic permeability  $\mu$ ,  $B = \mu H$ . Figure 7-2 shows relation curve of  $B$ ,  $H$  and  $L$ .

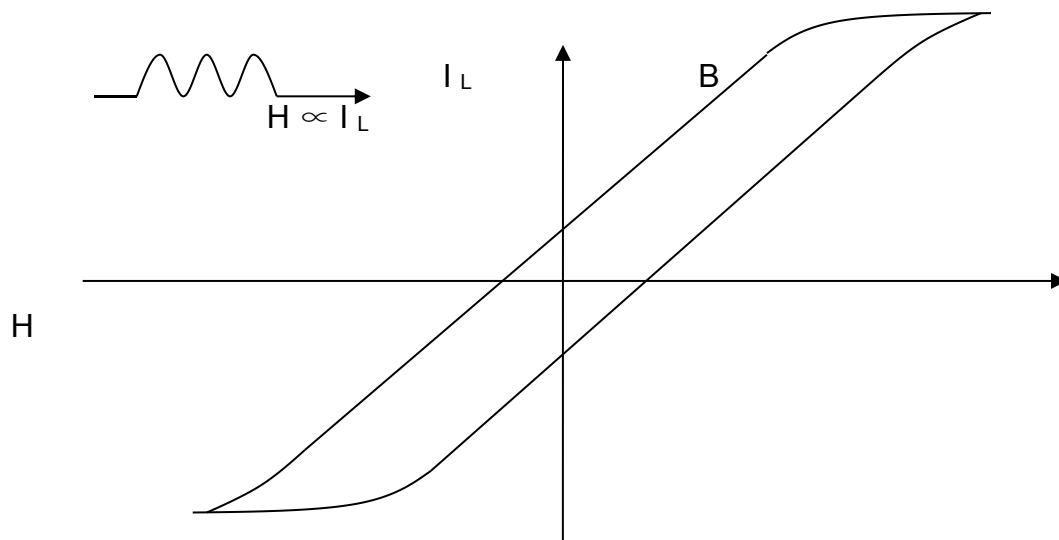

**Figure 7-1 Magnetization curve for inductance coil**

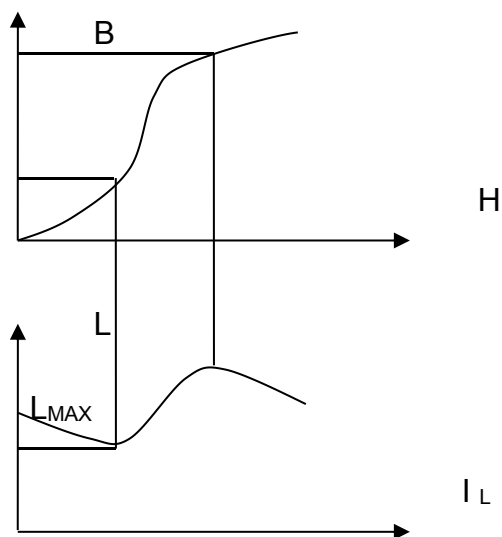

**Figure 7-2 Relation Curve for Magnetic Field Intensity and**

## Inductance

In the magnetic permeability area near the origin of coordinates, magnetic induction intensity increases slowly, and inductance is small too; subsequently, inductance increases as current increases. When exceeding saturation point, inductance will decrease dramatically as current increases, in this situation, measuring signals maybe have distortion, and the readings become unstable. On the other hand, dissipation of magnetic core will increase in some high-frequency area around some point. It depends on the materials and structure of magnetic core.

In a word, different measuring signals and frequencies will cause very different measuring results for inductor.

### 7.2 Use measuring fixture correctly

When metal is very close to the inductor, the leakage flux from inductor will generate eddy current in the metal. The quantity of eddy current is relative to the size and formation of measuring fixture. Different eddy currents will cause different measuring results. When users need to measure the inductor accurately, please let the samples be as far as possible from the metal.

### 7.3 Accuracy about Q value

Generally, the meter uses  $V/I$  (voltage/current) method to test Q value, so accuracy for Q value is not very high, especially, when testing high-value for Q via calculation, for instance,  $Q=X/R=1/D$ , if Q value is 100, and R value accounts for small percentage in the whole impedance, then, tiny change of R value will cause big change for Q value. R value changes 0.1%, namely, D changes 0.001, and Q value will change from 100 to 91 or 111.

### 7.4 Measurement with additional DC bias current

Generally, DC bias current is suitable for measuring inductor and transformer. Users can use special DC magnetization power and DC bias current. If there is no magnetization power, users can add magnetization current to inductor or transformer samples according to Figure 7-4 method.

In order to avoid the effect to measurement from additional circuit, users should adjust DC current to 0A, and then short circuit/open circuit and clear zero, at last, adjust to the required current to measure.

Figure 7-4: Lx: Inductor sample    Ex: Outside DC power

C1, C4: Isolating capacitor  $C1 \geq 1/(10\pi F)$ , F is measuring frequency, Withstanding voltage  $> E_x$

C2, C3: Isolating capacitor  $C2 = 1\mu F$ , Withstanding voltage  $> E_x$



**V6, V7, V9, V11: 1N40/5007 V1, V2, V3, V4, V5, V8:47V, 1W**

First, users should place a ammeter into the DC power circuit by series connection, and adjust DC voltage till get the required current. Take the ammeter out.

Both HS and LD wires should be as short as possible. Every testing leads, especially HS and LD, should use shielded wires.(Bold lead in the picture)

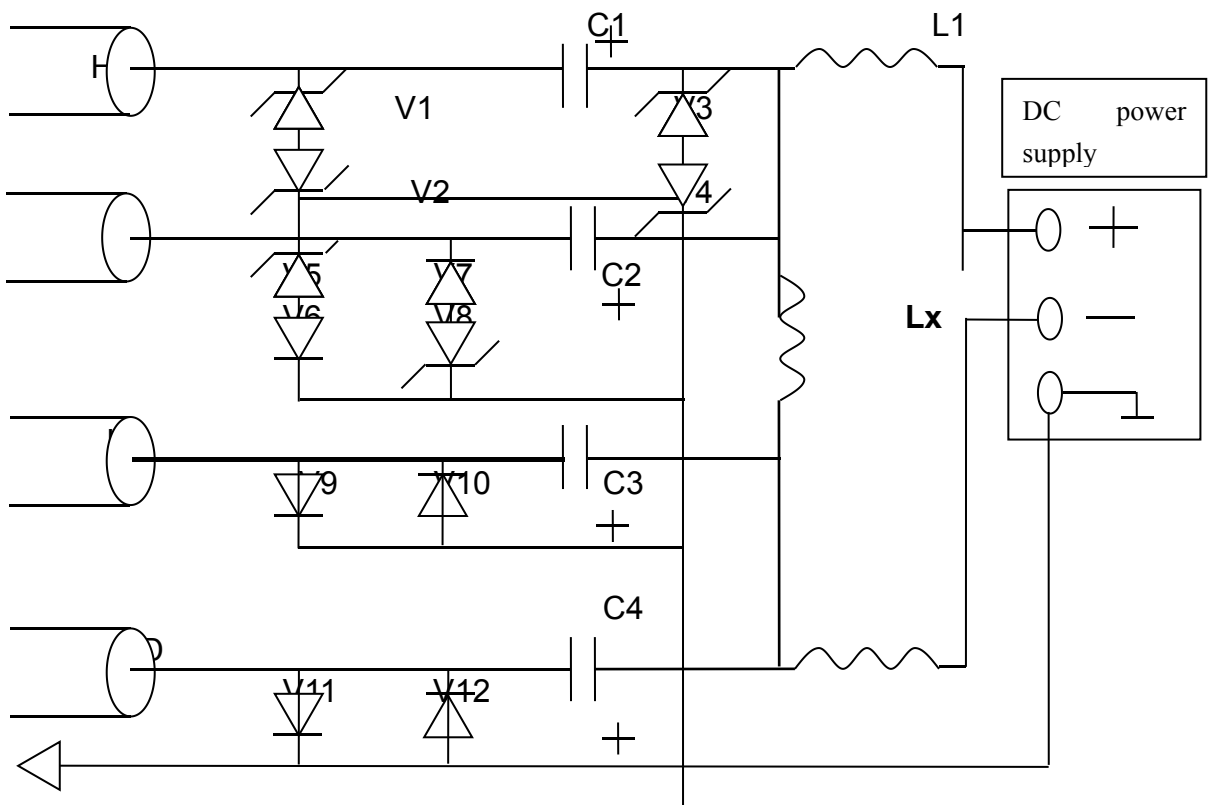

Figure 7-4 Impose outside DC bias current circuit

diagram

## Chapter 8    Packing List

1. Main unit x1
2. Measuring wire x1
3. Power cord x1
4. PDF Manual    x1

**Warranty: two years for non-human factor.**